

# Aesculap<sup>®</sup> MACS II

Modular Anterior Construct System for the Thoracic and Lumbar Spine  
Surgical Technique



Aesculap Spine

# MACS II

## Table of Contents

<b>A</b>	<b> </b>	<b>General Information</b>	<b>3</b>
<b>B</b>	<b> </b>	<b>Product Features</b>	<b>6</b>
<b>C</b>	<b> </b>	<b>Surgical Technique</b>	<b>10</b>
<b>D</b>	<b> </b>	<b>Thoracoscopic Technique</b>	<b>24</b>
<b>E</b>	<b> </b>	<b>Revision</b>	<b>34</b>
<b>F</b>	<b> </b>	<b>Assembly / Disassembly of Instruments</b>	<b>37</b>
<b>G</b>	<b> </b>	<b>Set Definition</b>	<b>38</b>

# A | General Information

## MACS II – At a Glance

Key elements of the MACS II system are:

- **Simplified instruments**

- **New pre-mounted set screw with centralizer**

provides a safe and secure set screw and instrument attachment point for ease of surgery

- **Click mechanism**

Ease of assembly and disassembly

- of the insertion instrument
- of the guiding sleeve for the stabilization screw

- **Simple locking mechanism**

- made possible by the pre-mounted set screw with break away design and torque controlled terminal locking feature



# A | General Information

## System concept

MACS II implants are used for the anterior mono- and multi segmental stabilization of the lumbar and thoracic spine.

MACS II is an evolutionary development of the clinically successful and biomechanically proven MACS TL implant system available since 1999. This development initiative has simplified the surgical procedure while maintaining the endoscopic capability of the MACS System.

The only implant change: The new set screw / centralizer sleeve instrumentation used to terminally lock the polyaxicity of the MACS TL construct.

## Implant materials and surfaces

- All implant components, apart from the pre-mounted set screw, are made of ISOTAN®F titanium forge alloy Ti6Al4V in accordance with ISO 5832-3.
- Pre-mounted set screw: Ti Grade 4B in accordance with ISO 5832-2 (pure titanium)
- Centralizer of set screw: XM 16 (1.4543) (does not remain in patient)

New implant component:  
Set screw with centralizer (pre-mounted)



## Indications

- Fractures
- Spinal tumor
- Degenerative disc disorder (spondylolisthesis, spondylolysis, spinal stenosis)
- Post-trauma instability

## Contraindications

- Fever
- Acute or chronic vertebral infections of a local or systemic nature
- Pregnancy
- Severe osteoporosis or osteopenia
- Medical or surgical conditions that could negatively affect the outcome of the implantation
- Dependency on pharmaceutical drugs, drug abuse, or alcoholism
- Adiposity
- Mental illness
- Severely damaged bone structures that could prevent stable implantation of implant components
- Bone tumors in the region of implant fixation
- Wound healing disorders
- Inadequate patient compliance
- Foreign body sensitivity to the implant materials
- Cases not listed under indications

# B | Product Features

## Modular system

The MACS II Twin Screw concept components:

- 2 set screws (pre-mounted with centralizer)
- 2 posterior polyaxial screws
- 2 clamping elements
- 2 anterior stabilization screws
- 1 stabilization plate
- 2 fixation nuts

Depending on the indication the following combinations are possible:

- **Twin Screw Standard**  
For anterior stabilisation T8-L4
- **Twin Screw XL**  
As standard version with augmentable XL screw for fusion in case of reduced bone density
- **Twin Screw Thoracic**  
Thoracic extension for small vertebrae T3-T8
- The combination of the lumbar and thoracic element is also possible.

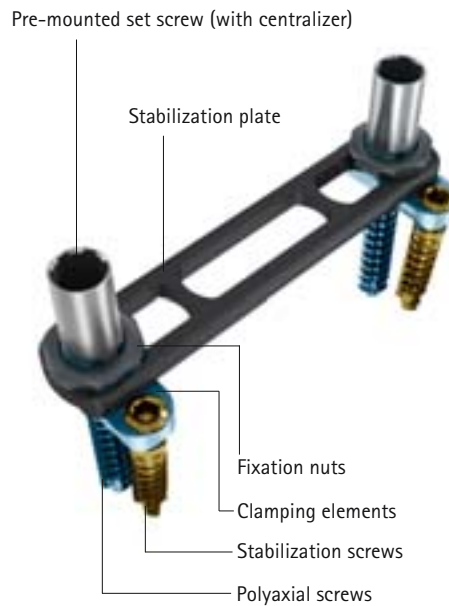

## Modular system

- Use with posterior fixation system and vertebral body replacement system possible
- Low profile of 9.9 mm for reduced tissue irritation



## B | Product Features

### Safety

- Safe screw positioning
- Simple guided instrumentation with centralizer
- Easy assembly and disassembly of instruments
- Easy guided locking mechanism



### Stability

- Clinically and biomechanically proven system with four point angle stability
- Optimal adaption of the implant construct to the spine thanks to poly-axiality of  $\pm 15^\circ$





## Approaches

- **Open**
- **Mini-Open**  
(Miaspas Mini TTA System)
- **Thoracoscopic\***  
(Miaspas TL System)

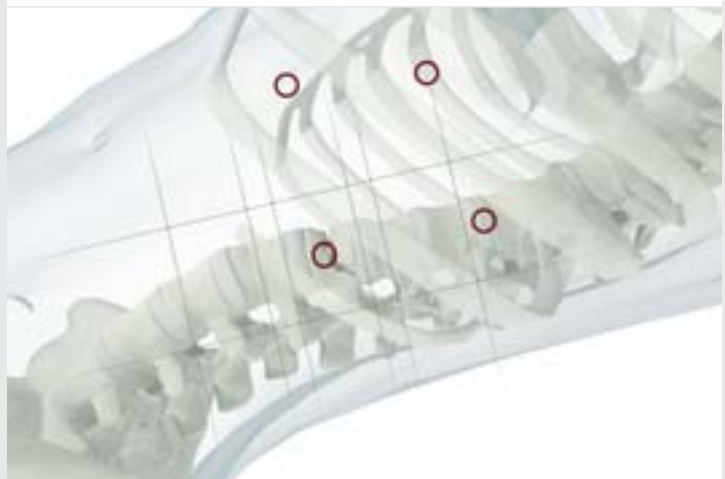
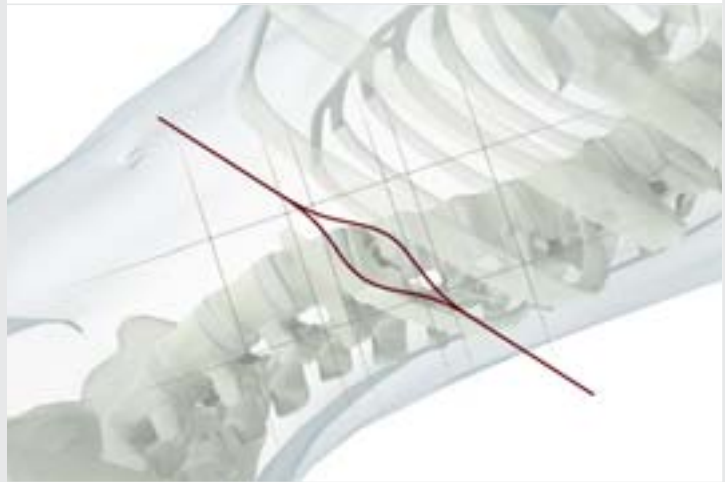

### NOTE:

For details concerning the thoracoscopic technique please see page 24 ff.

# C | Surgical Technique

## Preparation Screw Insertion Point

Insertion point is a function of screw type selection

### Twin Screw Standard and XL

Posterior polyaxial screw

- 10 - 13 mm from dorsal rim
- 10 - 13 mm from cranial or caudal endplate

Since the aim is to achieve a parallel implant position, the location of the screw insertion points should be identical in all instrumented vertebral bodies.



### Twin Screw Thoracic

The polyaxial screws of the thoracic clamping element are inserted centrally into the vertebral body.



### Twin Screw Thoracic and Standard combined

For a combination mounting, the standard clamping element is positioned as described above. The thoracic clamping element is applied in such a way that the plate runs parallel to the spinal axis.



#### NOTE:

Also see thoracoscopic technique / screw positioning page 28.

## Insertion K-Wires / Opening Cortical Bone / Insertion K-Wire Protection

### Insertion K-wire

Inserting the K-wire thread side of FW406S first into the K-wire inserter FW408R and rotate to secure it into place.

The correct position of the K-wire is controlled step by step via the imaging system on the precisely orthograde set vertebral body.

#### NOTE:

The correct aligned orthograde K-wire appears as a point when imaging, concentrically within the metal ring that forms part of the aiming device.

#### NOTE:

The correct positioning of the K-wire must be controlled step by step by the imaging system to avoid any misalignment and damage of soft tissue or wrong positioning of screws.

Positioning and impacting the K-wire with hammer FW243R until maximum possible depth of 20 mm.

### Open cortical bone

Remove insertion impactor and open cortical bone with FW408R.



# C | Surgical Technique

## Insertion K-Wires / Opening Cortical Bone / Insertion K-Wire Protection

### Remove K-wire insertion instrument

Insert the counter holder into the K-wire inserter FW408R and remove from the K-wire (apply counterforce on the K-wire using the counter holder).

#### NOTE:

The use of the counter holder prevents an undesired removal of the K-wire. Do not push K-wire ventrally with counter holder.



Inserting the second K-wire accordingly.



### Positioning of K-wire protection sleeve (optional)

Position K-wire protection sleeve FW394R with holding forceps FW326R (technique if corporectomy without insertion of polyaxial screw and clamping element is possible from a clinical point of view).



#### NOTE:

Preparation of the respective vertebral body, removal of discs and insertion of vertebral body replacement (e.g. Hydrolift).



## Pre-mounting of Polyaxial Screw / Claming Element / Set Screw

### Mounting of the polyaxial screw with clamping element

Assemble the polyaxial screw into the clamping element and place into mounting block FW429.

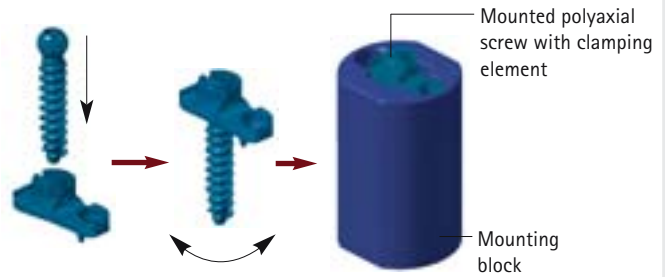

### Assembly of pre-mounted set screw and centralizer

Remove the pre-mounted set screw SX804T from the packaging using the torque wrench FW419R.

#### NOTE:

Keep packaging upright and handle with care to prevent set screw from falling out.

Push the torque wrench FW419R onto the pre-assembled locking screw until the stop position is reached. Visual check anti-rotation tabs are flush with the slots of the clamp element.

Complete assembly of the pre-mounted set screw onto the clamping element with a final tightening torque of (1.8 Nm).

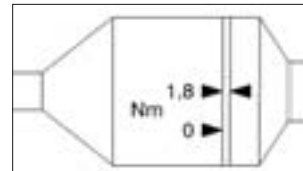

#### NOTE:

Torque wrench does not release. Please check to ensure markings match on 1.8 Nm.

Removing the completely assembled implant with the torque wrench FW419R from the mounting block. Remove torque wrench from the centralizer.



#### NOTE:

Ensure that the retaining lugs are positioned correctly in the grooves of the clamping element.

# C | Surgical Technique

## Mounting instruments / Removal K-Wire Protection Sleeve

### Mounting counter torque handle / insertion sleeve

Assemble the counter torque handle FW399R and attach to the insertion sleeve FW397R.

Attach the insertion sleeve FW397R ex situ to the centralizer and insert the cannulated screwdriver FW398R into the insertion sleeve.

#### NOTE:

The position of the counter torque handle can be aligned with the centralizer for better orientation.



### Optional removal of the K-wire protection sleeve

Remove the K-wire protection sleeves FW394R with holding forceps FW326R.

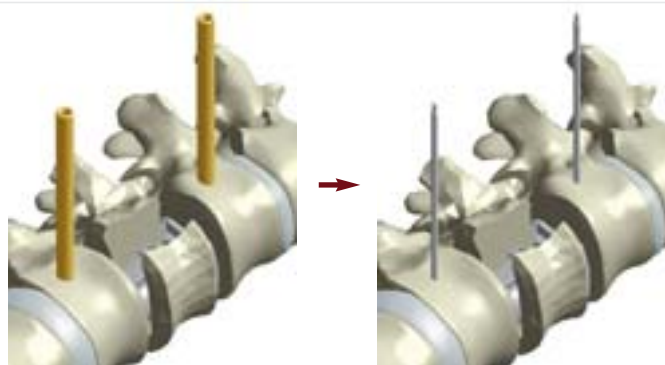

## Implantation Polyaxial Screw / Removal K-Wire

### Implanting the polyaxial screw and K-wire removal

The posterior polyaxial screw is guided down the K-wire and attached to the vertebral body by rotating 2-3 turns with the cannulated screwdriver FW398R.

The K-wire removal instrument FW406S is inserted into the cannulated screwdriver FW398R and attached onto the K-wire (1). Remove K-wire (2).

Insert the polyaxial screw with the cannulated screwdriver FW398R.

#### NOTE:

The clamping element must be maintained freely rotatable to ensure polyaxiality.

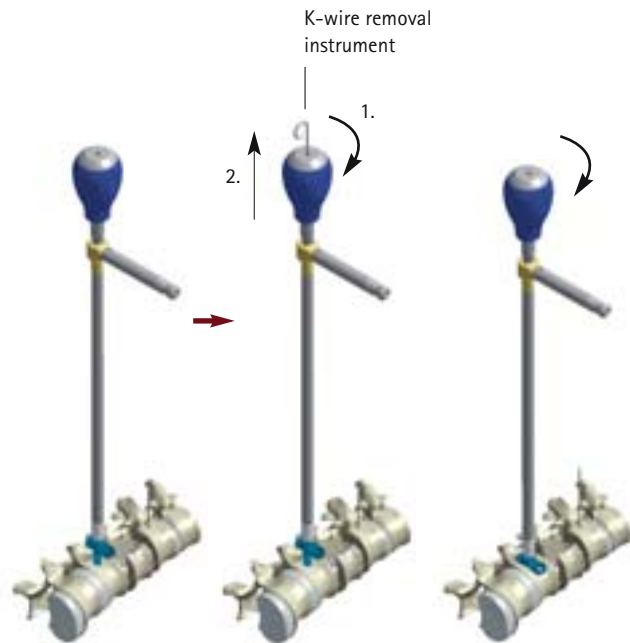

### Disassembly of cannulated screwdriver and insertion sleeve

Remove the cannulated screwdriver FW398R from the insertion sleeve FW397R.

Remove the insertion sleeve FW397R with the counter torque handle FW399R from the centralizer.

Insert the second polyaxial screw accordingly.

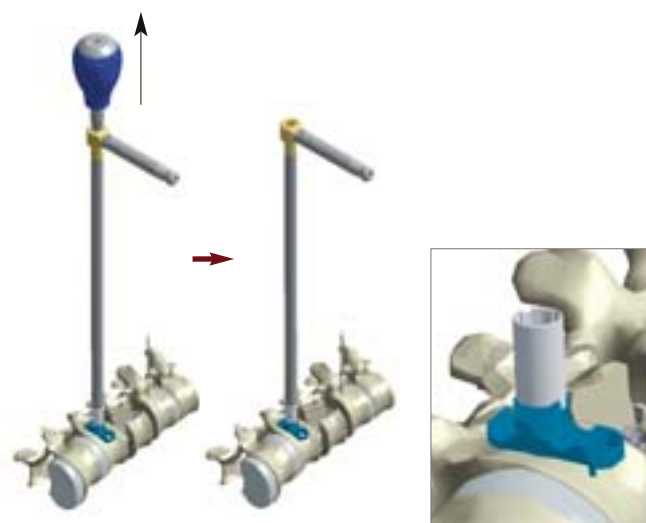

# C | Surgical Technique

## Optional – Assembly / Disassembly Centralizer Intraoperatively

**NOTE:**

Removing the centralizer is optional, if view during corporectomy is not sufficient.

### Assembly screw driver

Insert the set screw driver FW411R into the insertion sleeve FW397R and attach the 1/4" T-handle FW395R.

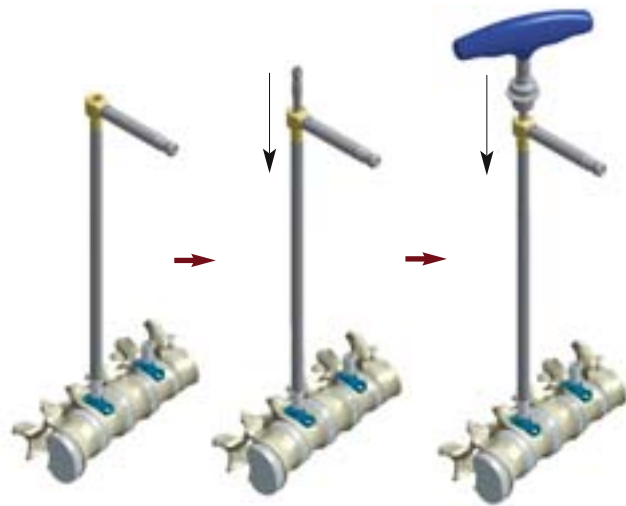

### Disassembly centralizer

Remove the pre-mounted set screw SX804T from the clamping element by rotating counter clockwise.

Perform corporectomy and insertion of the vertebral body replacement (e.g. Hydrolift) according to standard procedure.





## Optional – Assembly / Disassembly Centralizer Intraoperatively

### Centralizer assembly

Manual attach the centralizer SX804T using the assembled insertion sleeve FW397R with counter torque handle FW399R and set screwdriver FW411R.

Insert the torque wrench FW419R into the set screwdriver FW411R and tighten to 1.8 Nm.

#### NOTE:

Torque wrench does not release. Please check if markings match on 1.8 Nm.

### Disassembly instruments

Remove the torque wrench FW419R from the set screwdriver FW411R.

Remove the screwdriver for the set screw FW411R and insertion sleeve FW 397R.

Remove the insertion sleeve FW397R from the centralizer SX804T.

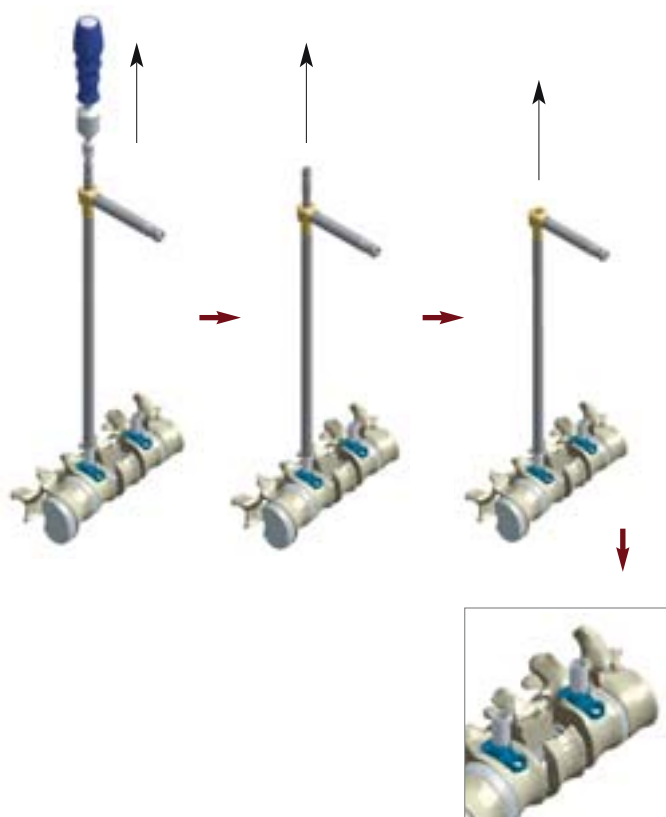

# C | Surgical Technique

## Stabilization Plate or SSE Rods Assembly

### Determine plate length

Measure the distance between the clamping elements with the measuring device FG045R.

The correct plate size is obtained by adding 30 mm to the measured value.

#### NOTE:

The correct plate length is obtained by adding 30 mm to the measured length.

### Stabilisation plate assembly

#### Open technique

Re-attach both insertion sleeves without counter torque handles to the centralizer. Slide the plate down over the insertion sleeves FW397R.

#### Mini-open / thoracoscopic technique

Slide the plate onto the centralizers using a holding forceps.

#### NOTE:

Flat labelled side of the stabilization plate up.

#### NOTE:

As the external thread of the clamping elements is very short, due to the overall flatness of the construct, care must be taken that the clamping elements move freely when inserting the plate or rods. Otherwise the fixation nuts cannot be easily grasped.

If the screws were driven in too deeply, surrounding soft tissue may be in the way of achieving correct plate positioning in the depressions of the clamping



element, and thus of achieving correct fixation. To remedy, the polyaxial screw should be slightly removed.

The fixation nuts must be tightened smoothly and easily. If the threads of the clamping element are damaged, it impossible to achieve safe assembly of the plate and the clamping element. If this happens, the clamping element must be replaced!

## Stabilization Plate or SSE Rods Assembly

### SSE rod assembly

**NOTE:**

SSE rods are used for multisegmental treatments (longer than 100 mm) to align according to the anatomy of the spine.

Both rods must be pre-bent with rod bending forceps FW013R to replicate or correct the patient's anatomy.

Since the anterior depression of the clamping element is shaped slightly shallower than the posterior depression, the posterior rod, which is to be inserted first, can be secured by slightly tightening the nut.

After that, the anterior rod can still be easily inserted. Both rods are fixated with the fixation nuts, in same way as described for the plate.

Falta o texto aqui

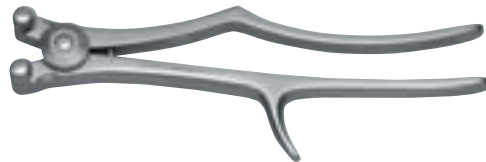

# C | Surgical Technique

## Fixation Nut Assembly

Pick up the fixation nut SX802T using the fixation nut driver FW417R. Assemble the insertion sleeve FW397R with the counter torque handle FW399R into the fixation nut driver FW417R. Clicking into the centralizer SX804T.

Assemble the fixation nut SX802T using the T-handle of the nut driver FW417R and tighten with the torque wrench FW416R with 15 Nm (apply counterforce with counter torque handle FW399R).

**NOTE:**

Torque wrench FW416R releases with 15 Nm.

Remove the insertion sleeve FW397R with the counter torque handle FW399R from the fixation nut driver FW417R (apply counterforce using fixation nut driver). Remove fixation nut driver from the fixation nut.

### Optional – locking insertion sleeve

As an option the insertion sleeve FW397R can be locked with the centralizer by inserting the screw driver FW411R.

**NOTE:**

Mount of the second fixation nut accordingly.

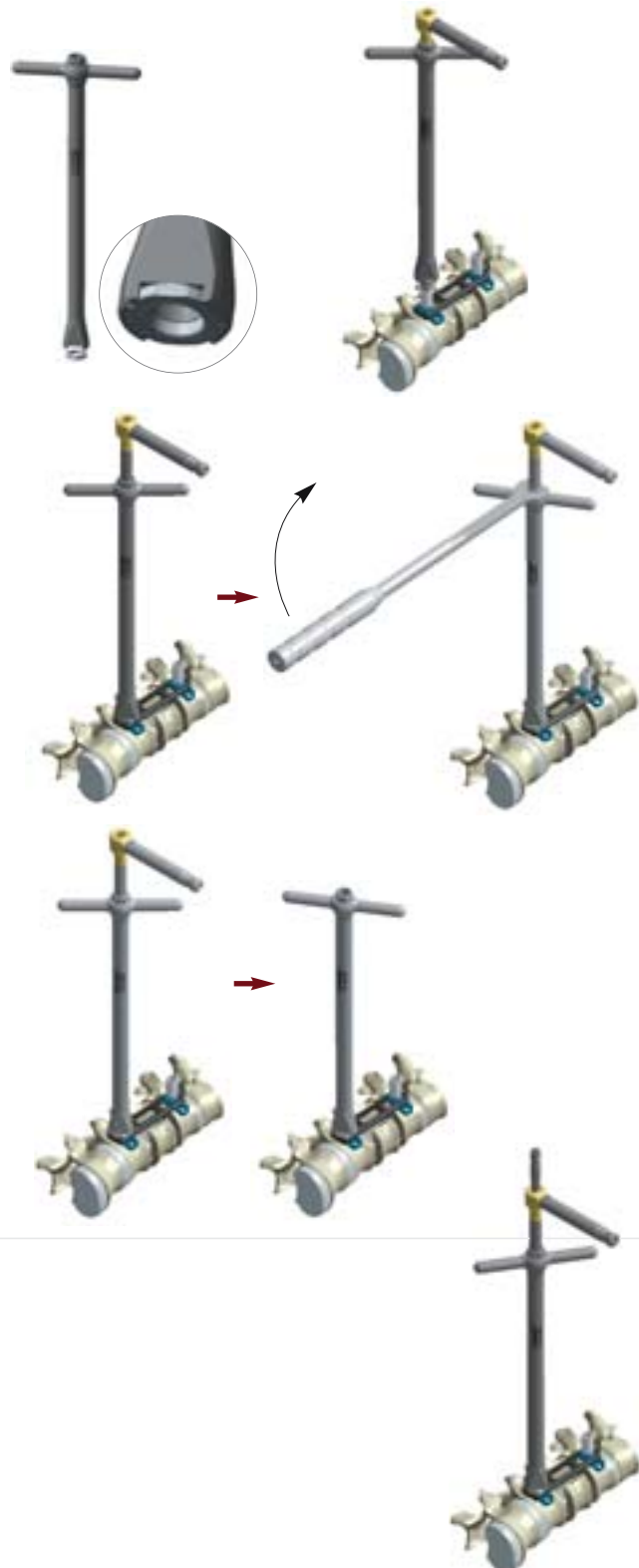

## Polyaxial and Stabilization Screw Implantation

### Polyaxial screw implantation

Alternate tightening of polyaxial screws using the ball screwdriver FW396R.

#### NOTE:

A maximum one turn per side, to avoid a clamping of the screw driver between clamping element and pre-mounted set screw.

Remove ball screwdriver FW396R by turning slightly clockwise and counterclockwise (while pulling slightly).

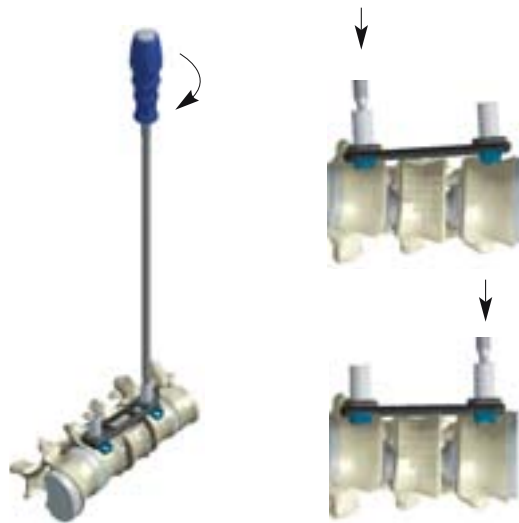

### Targeting sleeve assembly

Attach the lumbar targeting sleeve FW409R onto the centralizer and open cortical bone with lumbar punch FW407R.

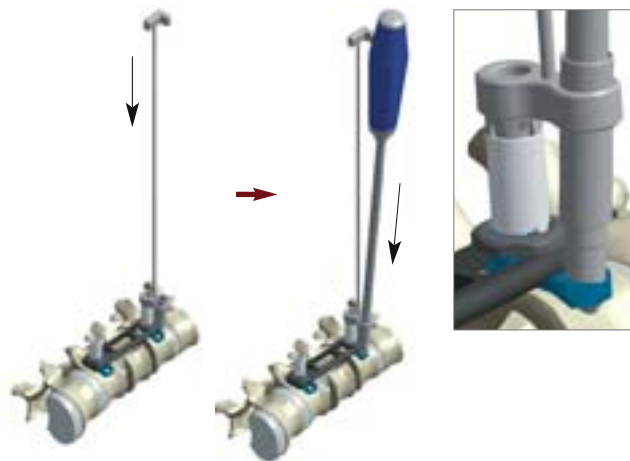

### Anterior stabilisation screw insertion

Insert the screw revision instrument FW336R into the cannulated screwdriver FW398R and assemble with the stabilisation screw.



# C | Surgical Technique

## Implantation Polyaxial Screw and Stabilization Screw

Assemble the stabilization screw into the vertebral body until it is fully inserted into the clamping element.

### Remove instruments

Disassemble the screw revision instrument FW336R and removing it.

Remove the cannulated screwdriver FW398R and disassemble the lumbar targeting sleeve FW409R from the centralizer SX804T.

### Optional – Removing targeting sleeve

#### NOTE:

Emergency situation – if targeting sleeve FW409R cannot be removed from centralizer due to adverse surgical conditions.

Assembling a 40 mm or longer stabilization screw with cannulated screwdriver FW398R and assemble revision instrument FW336R.

Assemble the lumbar stabilization screw into the lumbar (or thoracic) targeting sleeve thread thereby removing the targeting sleeve from the centralizer SX804T.

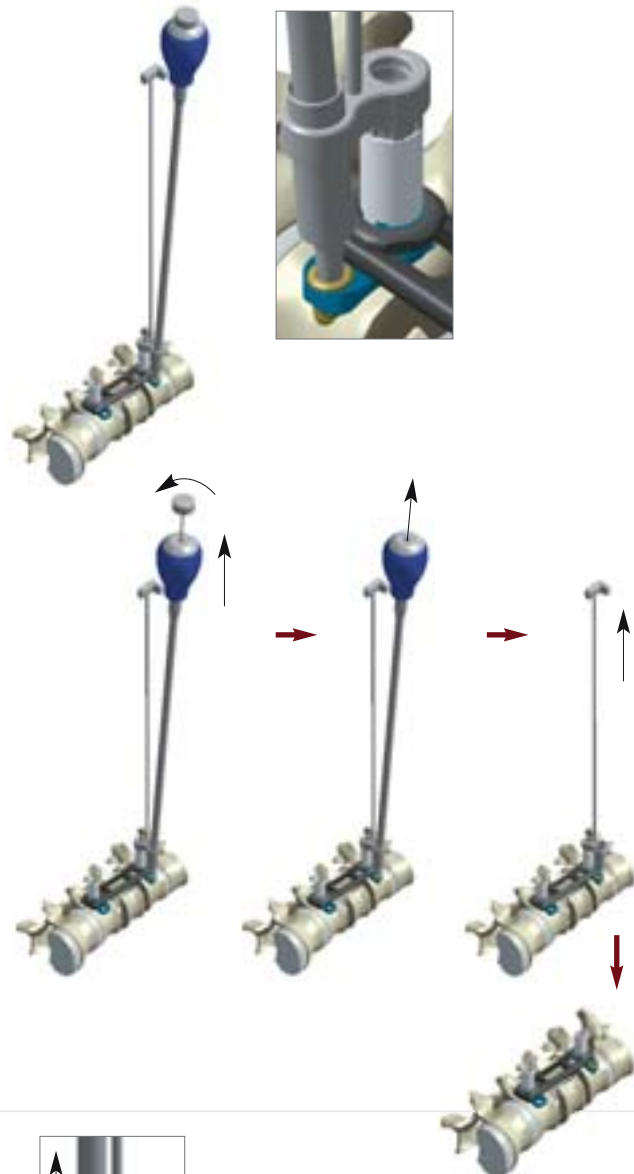

#### NOTE:

The used screw must be eliminated.

## Locking of Polyaxiality With Set Screw

### Mounting instruments

Attach the insertion sleeve FW397R with the counter torque handle FW399R onto the centralizer SX804T and insert the screwdriver for the set screw FW411R into the insertion sleeve.

**NOTE:**

The marking on the screwdriver FW411R must be covered completely to avoid any malfunction!

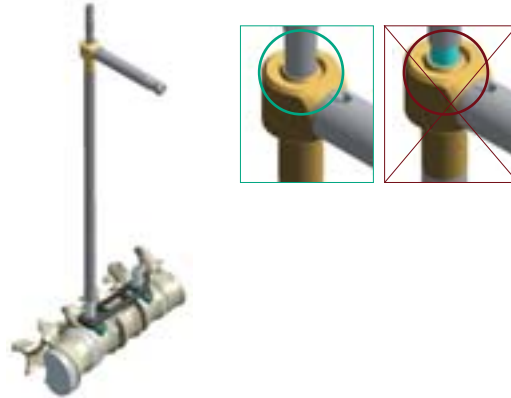

### Locking set screw

Attaching the 10 Nm torque wrench FW412R to the screwdriver for the locking screw FW411R. Turning the handle until locking the screw in 2 clicks.

**NOTE:**

The locking mechanism is made in 2 steps:

- First click – break-off screw head
- Second click – Release of torque wrench and locking of polyaxial screw with 10 Nm

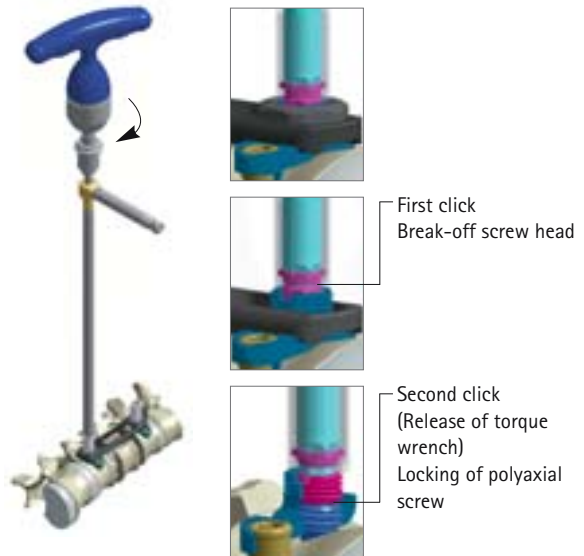

### Removing instruments

Removing the 10 Nm torque wrench with the screwdriver for the set screw FW411R.

Removing the centralizer and break-off screw head SX804T from the insertion sleeve FW397R.

**NOTE:**

Eliminate removed centralizer with brak-off screw head.

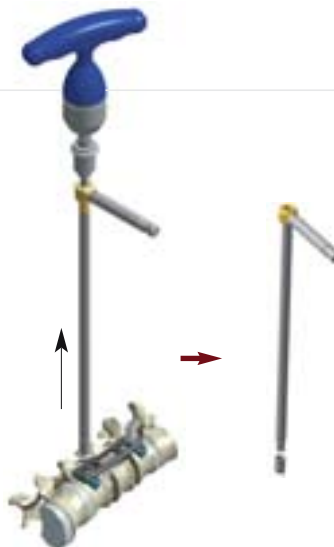

# D | Thoracoscopic Technique

## General Information / Advantages and Disadvantages / Indications

The drive towards a reduction of access morbidity is characterized by two steps of development:

The introduction of long shaft instruments eliminated the necessity for the surgeon's hand having direct access to the operating site. This problem was overcome, in turn, by using an endoscope, also the visualization of the site was solved. Comparable developments for operations in other regions of the body, the adaptation of a completely endoscopic technique to the requirements of spine surgery were further developments.

In principle, the endoscopic access to the lumbar and thoracic spine must be considered as an alternative to the open access technique. The endoscopic access to the thoracic spine offers the convincing advantage that, once a pneumothorax has been applied, the surgeon can perform a gasless operation on the spine in the thoracic cavity. Fenestration of the diaphragm allows access to the thoracolumbar transition region through the retroperitoneal access canal, making the majority of all fracture provisions accessible to this alternative technique. The thoracoscopic technique of provision is guided by the conventional open procedure. Accordingly, the patient is put into a stable lateral position. For the surgeon, this position facilitates the change to the thoracoscopic technique, and if any complication cannot be managed thoracoscopically, the problem can be approached immediately by widening the access. The alternative ventral position entails a significantly longer reaction time due to the necessary emergency repositioning of the patient, in the case of a hemorrhage of a large blood vessel.

The safety of endoscopic interventions at the spine primarily depends on the existence of fixed orientation marks.

MACS II takes account of this requirement, in the way that the posterior polyaxial screws are inserted at the beginning of the intervention, and serve as landmarks for the length of the procedure. The following operating steps largely follow the conventional open procedure.

### Advantages:

- Intercostal mini access without rib retraction or resection
- Excellent intraoperative view of the target area through 30° optics
- combined with a modern video transmission system
- Efficient and safe anterior decompression of the spinal canal
- Tissue-preserving provision for multisegmental and multilevel pathologies
- through additional mini access openings
- Reduced blood loss
- Low pre- and postoperative morbidity thanks to earlier extubation
- Less pain and faster rehabilitation

### Disadvantages:

- Increased complexity of anesthesia (e.g. double-lumen intubation)
- Longer learning curve for the endoscopic operating technique

### Indications:

- The indication for a thoracoscopic treatment is the same as the indications for the open technique.

### Contraindications:

- Significantly restricted cardiopulmonary function
- Acute post-traumatic pulmonary function disorder
- Significant blood coagulation disorder



## Devices and Instruments / Patient Positioning

### Devices and instruments

- Video transmission chain
- Suction / irrigation unit
- Lung and diaphragm retractor
- Instruments for trocar accesses
- MACS II instrument / implant sets
- Long shaft instruments for the thoracoscopic preparation of the vertebral structures and for the resection of intervertebral disc and bone material (MIASPAS TL)
- Instruments for bone grafting from or vertebral body replacement system (e. g. Hydrolift)
- Emergency set for thoracotomy / thoracophrenolumbotomy

### Patient position

- The intervention is executed with the patient in an exact lateral position (support scapula, arm, sacrum, symphysis).
- Right-side access: T3 to T8
- Left-side access: T9 to L4

#### NOTE:

Follow recommended position OR team, monitor, imaging device.

If the spine segment to be instrumented is covered by the aorta, access from the opposite side!

Video transmission chain:

- 3-chip camera
- Rigid endoscope 30°
- Xenon lightsource
- 2 monitors (operating surgeon / assistant)

Miaspas TL

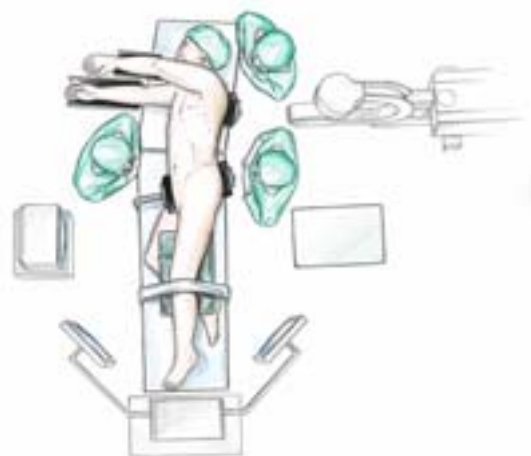

# D | Thoracoscopic Technique

## Access

### Thoracoscopic standard treatment

This technique is carried out through four mini-access portals, which are kept open by tissue-protecting plastic trocars:

- Optical system
- Lung retractor
- Suction / irrigation tube
- Working channel

As thoracoscopic surgery requires triangulating operation of the instruments, the portals must be positioned in such a way that the target area is accessible through any one of the portals. Also, the working channel should be approximately ortho-grade in relation to the target area, so that the corporectomy and the introduction of the implant will not be made more difficult by the need to handle the instruments aslant. For multisegmental treatments, the obvious option would be an exchange of roles between the working channel and the optics portal.

#### NOTE:

An incorrectly positioned port can become a considerable hindrance to the surgical procedure when the thorax is rigid. Therefore, portals should be planned and applied with foresight and diligence. If the trocar position is suboptimal, the surgeon can try reaching the adjacent, more favorable intercostal space by subcutaneous tunneling from the same skin incision.

The outlines of the vertebral bodies to be fused have to be clearly identified under X-ray control, and marked on the skin surface. Diagonal projections should be avoided under all circumstances, due to the distance between the skin and the

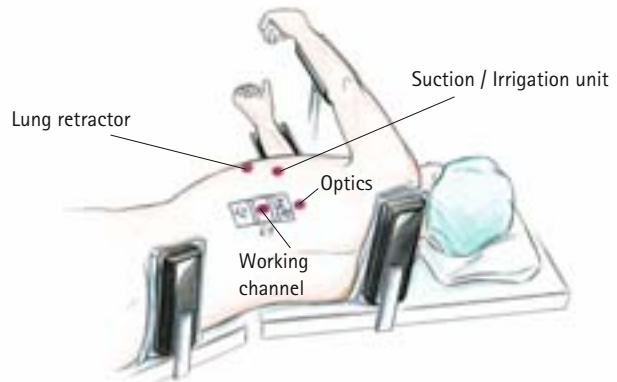

operating site. A diagonal projection would result in an incorrect trocar position.

The working channel is sited in a perpendicular projection above the target area, usually above the fractured vertebra. The optical channel, too, is positioned perpendicularly above the spine, at a distance of two intercostal spaces towards cranial. For fractures of the middle and upper thoracic spine, the optical channel is sited at a distance of two intercostal spaces from the working channel, towards caudal. The trocars for the suction / irrigation tube and the retractor are applied approx. six inches ventral (roughly along the anterior axillary line) from the working channel and the optical channel.

#### NOTE:

To avoid mutual obstruction of the instruments, the distance between the accesses must not be too close.

The first channel to be opened is the optical channel. To avoid damage to the parenchyma of the lungs, single-lung aspiration is applied and the thorax is opened through an approx. 1.5 cm long mini-thoracotomy incision. The first trocar ( $\varnothing$  10 mm) is inserted with the collapsed lung displayed. The remaining trocars are sited under videoscopic control.

## Site Setup

The camera assistant must maintain steady camera handling. Ideally the operating site should be displayed on the monitor in a manner the surgeon is familiar to. With the camera aligned accordingly, the spine should be displayed parallel to the bottom edge of the monitor screen. The structures situated ventral from the spine are displayed in the upper part of the screen. In accordance with the working direction of the surgeon, the right / left edges of the screen represent the cranial / caudal boundaries of the site.

Unobstructed view of the operating area, which is essential, must be maintained by the first assistant. As the camera setup has been adjusted to the needs of the operating surgeon, the first assistant will see a laterally reversed image of the site, which will make it more difficult for the assistant to maintain visual control of his or her instrument handling. This problem can be overcome either by relying on the assistant's experience or electronically, through inverse image display on the assistant's monitor (only applicable if two monitors are used).

Slight parenchymal adhesions can often be easily loosened with the blunt shaft swab. In cases of extended scarring, the risk of damaging the parenchyma necessitates a decision whether a switch-over to the conventional method is indicated.

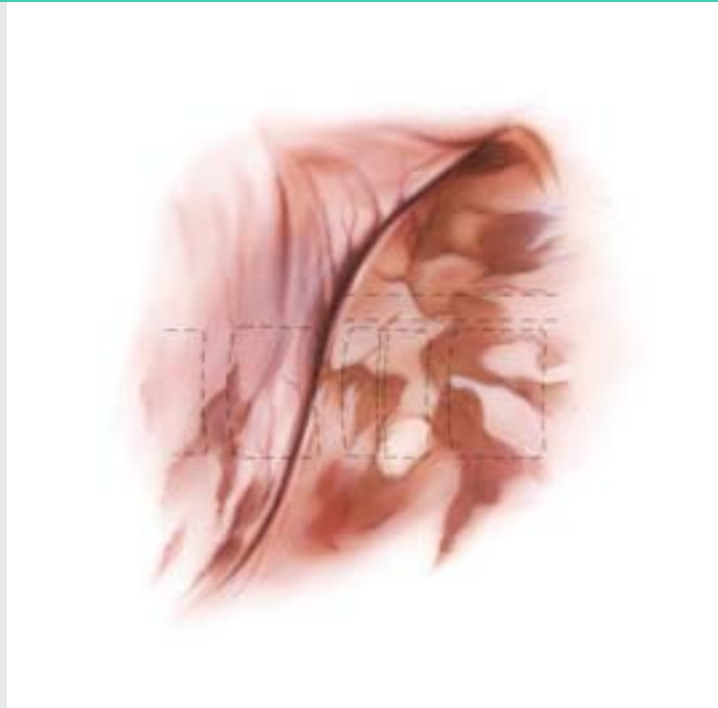

The diaphragm and the collapsed lung are carefully pushed towards medial, using the retractor, until the spine becomes visible. The height of the fractured vertebral body is often marked by a hematoma. Lesions below the diaphragm are accessible through diaphragm splitting (see page 31 ff).

### NOTE:

Even with rounded retractor blades, organ (spleen, liver) or vascular lesions cannot be excluded if excessive pressure is applied to the tissue!

# D | Thoracoscopic Technique

## Screw Position

While the thoracoscopic operating method provides excellent visibility of all details in the target area, the general overview is hampered by the lack of a three-dimensional impression. This deficit can be compensated by using orientation marks, which, ideally, are applied at the beginning of the operation. The implantation sequence with MACS II allows for this fact, in the way that the posterior polyaxial screws including the clamping elements are applied prior to the preparation and corporectomy. Monitored via the imaging system, the screw insertion points are marked with Kirschner wires without prior opening of the pleura.

Because of the higher bone strength in the region of the vertebral end plates, the screws are preferably inserted in the cranial or caudal third of the vertebral bodies. Where pedicle screws are already imbedded, the procedure must be adapted to the situation. If the bone strength is normal, monocortical screw fixation is sufficient.

The necessary screw length is determined from the CT scan.

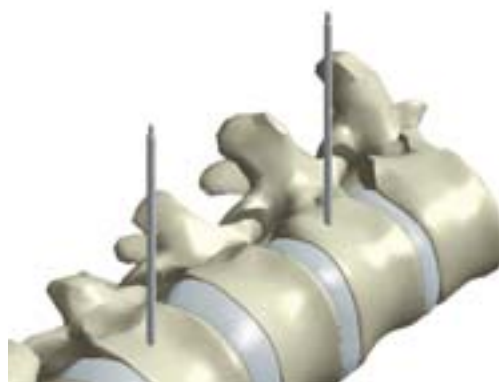

### NOTE:

When the plate or rod is fixed to both the clamping elements, the latter are forced into a position perpendicular to the implant axis. This also determines the position of the ventral stabilizing screw. To avoid the risk of mispositioning the ventral screw in the intervertebral disc space, any axial divergence between the spine and the implant must be avoided under all circumstances. This risk exists, especially, if the posterior screws are positioned very close to an end plate, and for longer constructs.

### NOTE:

Also see chapter preparation screw position pointing and placing K-wires page 10 ff.

## Hemostasis

The effectivity of hemostasis in endoscopic interventions essentially depends on the level of experience of the operating surgeon and team.

If blood spraying occurs, the surgeon must immediately decide from the intensity and localization of the hemorrhage, whether hemostasis can be reliably achieved endoscopically or rather openly, following an emergency thoracotomy.

There are no general rules of procedure for such cases.

However, according to experience, due to the enlargement effect of the optical system, even minor incidents of blood spraying often appear stronger than they really are. By immediate compression of the source of the hemorrhage, using the suction syringe or the shaft swab, the situation can be defused in most cases, if overview is maintained, so that a targeted hemostasis can be performed.

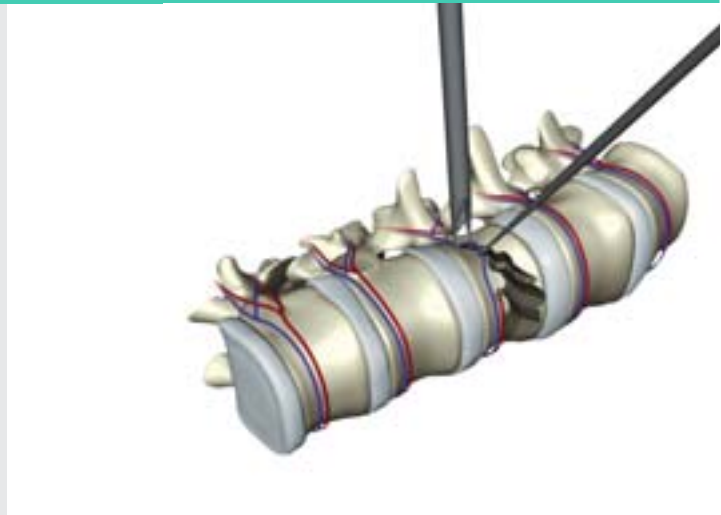

Untargeted, over-rushed hemostasis without visibility should be avoided under all circumstances.

The segment vessels of the vertebral bodies to be instrumented can be preserved in most cases.

The hemorrhage from a vessel that was accidentally damaged during positioning of the screw usually stops when the screw is driven into the bone.

# D | Thoracoscopic Technique

## Corpectomy

The central aim of the operation is the reconstruction of the loadbearing capacity of the ventral spine.

To achieve this through the most common technique, a lesion-bridging fusion between the neighboring intact vertebral bodies is created, abandoning the segmental function. While autologous material is considered the gold standard for pressure proof support and defect filling, alternative implants such as titanium baskets are also increasingly used.

The extent of the corpectomy depends on the degree of spinal dislocation, and how far the vertebral body has disintegrated, as well as on the space required by the vertebral body replacement. The size of the bone graft bed should be appropriate for the bone graft size so that there is as much contact area as possible between the blood-rich bone graft bed and the chip.

The thoracoscopic corpectomy requires long-shaft resection instruments (e.g. MIASPAS TL). The instrument set includes chisels, rongeurs, punches and curettes with graduated working shafts. The scale allows continuous control of the working depth and thus compensates for the missing 3-dimensional view of the endoscopic operation.

For reasons of safety, these instruments should be controlled with both hands.

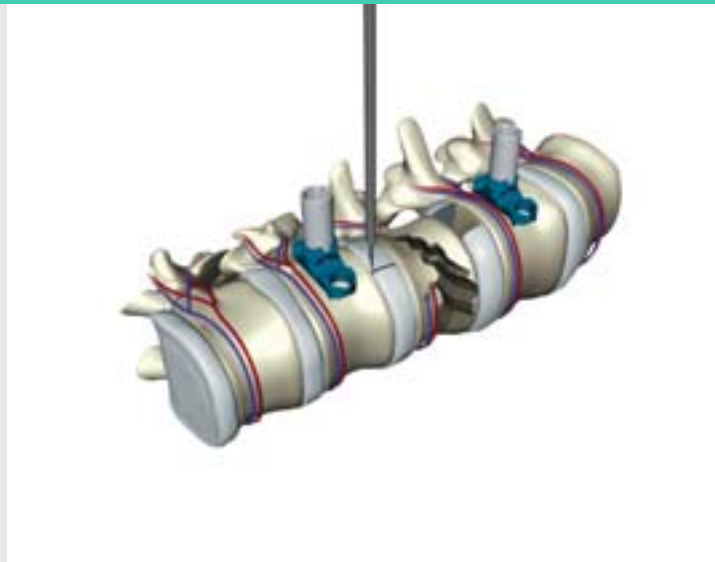

### NOTE:

Using a long-shaft milling cutter is possible, in principle, although it entails a considerable risk of damaging the adjacent vascular and soft-tissue structures if the cutting head gets jammed.

The procedure of thoracoscopic resection is in line with the open technique of corpectomy. As standard procedure it is not detailed here.

The thoracoscopic technique of dorsal edge resection, which can become necessary, is described in the chapter 'Special technique'.

## Special Technique – Diaphragm Splitting with Access into the Retroperit. Cavity

If the anatomy is regular, the central attachment of the diaphragm is located approx. at the height of T12.

Consequently, fusions in the region T12 / L2 cannot be done by performing only a lumbotomy or only a thoracotomy. Instead, such fusions require a traumatizing dual-cavity intervention involving an extended ablation of the diaphragm. However, using the thoracoscopic technique, the sinus phrenicocostalis, which reaches down to the L2 level, can be used for reaching fractures at the thoracolumbar transition. With access positioned exactly cranial from the lateral onset of the diaphragm, the diaphragm dome pushed aside, and an incision applied at the central attachment



of the diaphragm, the required retroperitoneal access to the spine is achieved. The option of thoracoscopic provision can only succeed if an orthograde access can be found.

As the patient is in a lateral position, the intra-abdominal pressure is usually lower on the access side. Nevertheless, the patient should be sufficiently relaxed to prevent excessive retractor pressure.

### Technique

The following is a description of the thoracoscopic technique of diaphragm splitting with left-side access.

With the operating site set up, the onset of the diaphragm at the spine is identified. With an ultrasound knife (alternatively: a monopolar preparation hook) the course of the incision is marked parallel to the onset, leaving a margin of about 1 cm width and keeping sufficient distance to the aorta. When doing this, the diaphragm should be slightly tensioned, using the retractor. The length of the incision depends on which caudal vertebral body requires instrumentation. Following the marking, the parietal pleura and the diaphragmatic muscles are severed, layer by layer, until the retroperitoneum lies open. Looking at the fascia of the psoas muscle, the incision is gently opened to the required width, using the preparation swab, and kept open with the repositioned retractor.

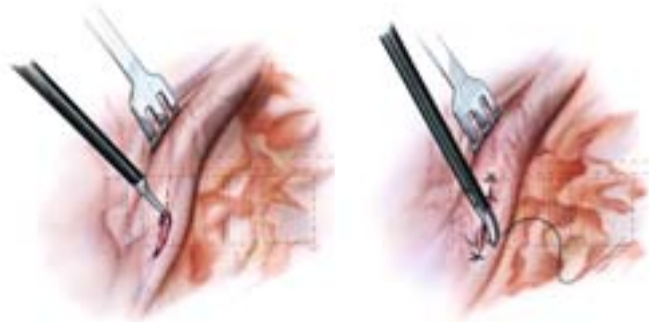

With the retroperitoneal fat tissue carefully pushed aside, the psoas muscles are mobilized, beginning at the anterior vertebral edge, and the target vertebra is prepared. Depending on the muscle volume, it is also possible that a muscle gap must be prepared by bluntly forcing apart along the direction of the muscle fibers. Any muscular hemorrhage occurring at this stage must be coagulated immediately.

Once the fusion has been completed, the diaphragm is closed by adapted single-head sutures or by means of an endo-stapler. Experience shows, thanks to the incision close to the onset of diaphragm, there is no reason to expect hernia formation, even if the suture is not "watertight".

# D | Thoracoscopic Technique

## Special Technique – Spinal Decompression of the Dorsal Rim

The indication for clearing the osseous spinal canal (Fig. 49) is undoubtedly given when there are neurological symptoms. If the posterior wall has been dislocated without giving rise to neurological failures, there is a relative indication for a posterior wall resection, mainly depending on the extent of the stenosis.

However, to reduce the risk of a later myelopathy, decompression should be considered.

According to experience, thoracoscopic posterior wall resection is very effective, due to an imaging system that is very similar to those used in microscopic surgery. In the following we describe the technique of anterior spinal decompression.

### Initial situation

As described the working corridor is marked by the embedded MACS II clamping elements.

In cases of an unstable posterior wall, the partial corpectomy should initially be carried out with a safety zone of approx. 5 mm to the posterior edge. This measure generally prevents any undetected further dislocation of the posterior wall into the spinal canal while the anterior resection is performed.

With the pedicle of the vertebral arch resected and the dura in view, the aim is now to mobilize the dislocated posterior edge into the previously prepared vertebral defect, where it is to be removed.

The anterior direction of the resection with view of the dura should be maintained!

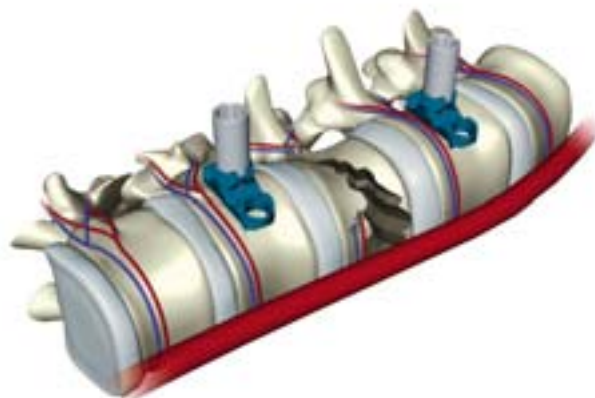



## Special Technique – Spinal Decompression of the Dorsal Rim

### Technique

The raspatory is used for displaying the pedicle facing the surgeon.

The lower boundary of the pedicle is probed with the nerve hook. Beginning from there, the pedicle is ablated step by step in a cranial direction, using a punch.

#### NOTE:

To prevent a lesion of the nerve roots or the dura, the progress of this procedure must be checked repeatedly, using the nerve hook and the dissector.

If the pedicle is of a larger diameter, the effective lift of the punches may not be sufficient. In such cases the pedicle must first be narrowed from lateral. Appropriate caution must be applied if the pedicle is fractured, since the neurogenic structures may be adhered or jammed, or could be contused by fragments.

With the pedicle resected, the dura becomes visible. Now the dislocated posterior edge can be mobilized ventrally, using a scoop, under visual control. Fragments fixed to the anulus fibrosus are too elastic, in most cases, and must be removed directly. The same procedure is necessary if fragments of the intervertebral disc are found.

Usually, venous hemorrhages or minor dura leakage can be sufficiently covered by a hemostypticum. Major dura leakage must be treated with a suture. Once the anatomic width of the spinal canal has been restored, the dura is protected by a single-layer cover of hemostyptic dressing.

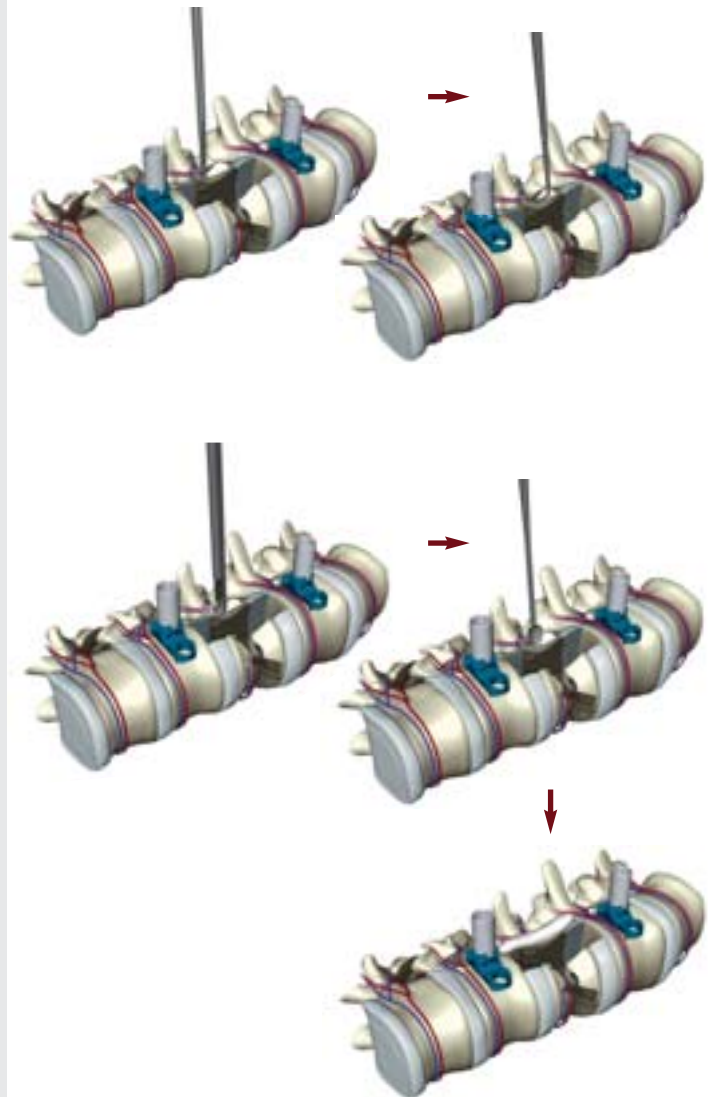

If a bone transplant / vertebral body replacement implant is put into place at a later stage, care must be taken that sufficient distance to the myelon is maintained. The same applies when spongiosa is attached.

# E | Revision

## Instrumentation for Revision – Clamping Element TL

### Disassembly set screw

Positioning the fixation nut driver FW417R on the fixation nut.

Attaching the T-handle with 1/4" coupling FW395R on the screwdriver for the set screw FW411R.

Inserting the screwdriver for the set screw FW411R with T-handle FW395R into the set screw and unscrewing the set screw (apply counterforce through fixation nut driver).

Disassemble the second set screw accordingly.



Pull ring for connection



## Instrumentation for Revision – Clamping Element TL

### Disassembly stabilisation screw

Inserting the cannulated screwdriver FW398R into the stabilisation screw.

Inserting the screw revision instrument FW336R into the cannulated screwdriver FW398R and screwing it into the stabilisation screw.

Unscrewing the stabilisation screw using tractive force (to overcome the locking mechanism).

Disassemble second stabilisation screw accordingly.

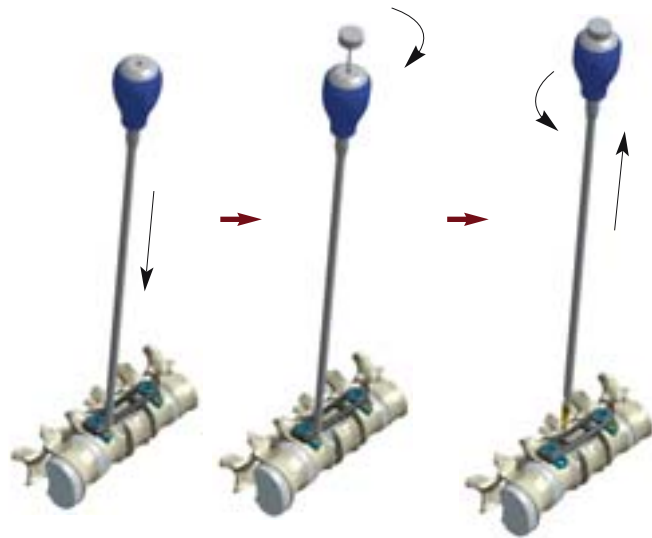

### Removal polyaxial screws with implant construct

Alternating unscrewing of the polyaxial screws from the vertebral bodies using the ball screwdriver FW398R.

Removing the complete implant assembly using a holding forceps FW326R.



# E | Revision

## Instrumentation for Revision – Clamping Element T

### Disassembly set screw

According to description for clamping element TL.

### Disassembly stabilisation screw

Insert the thoracic screwdriver FW342R into the thoracic stabilization screw and tightening the screw locking mechanism.

Unscrewing the thoracic stabilization screw.

If the thoracic stabilization screw cannot be disassembled using the screwdriver FW342R and is turning freely, the screw revision instrument FW336R can be assembled into the screw which can then be pulled out of the clamping element.

### Removal polyaxial screws and implant construct

According to description for clamping element TL.

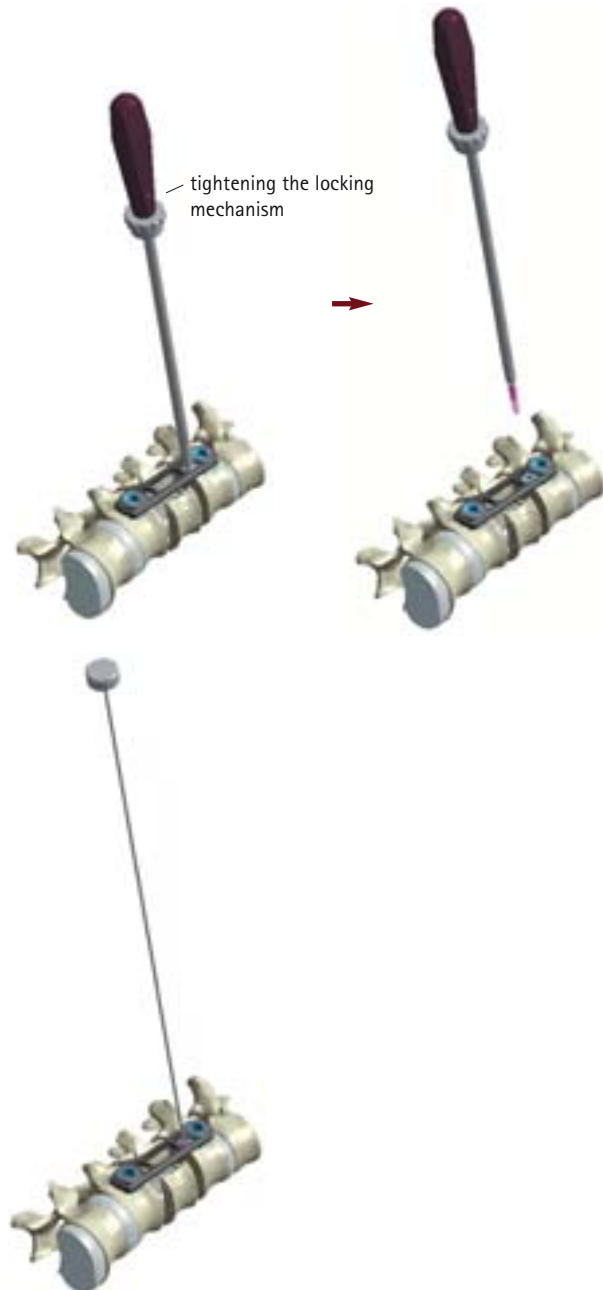

# F | Assembly / Disassembly of Instruments

**MACS II Counter Torque Handle**  
FW399R

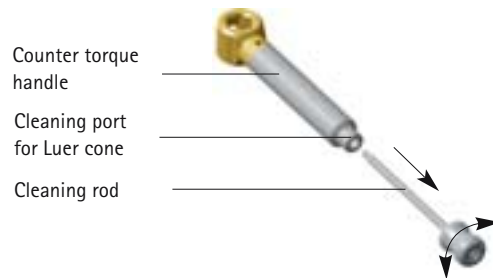

**MACS II K-Wire Insertion Instrument**  
FW408R

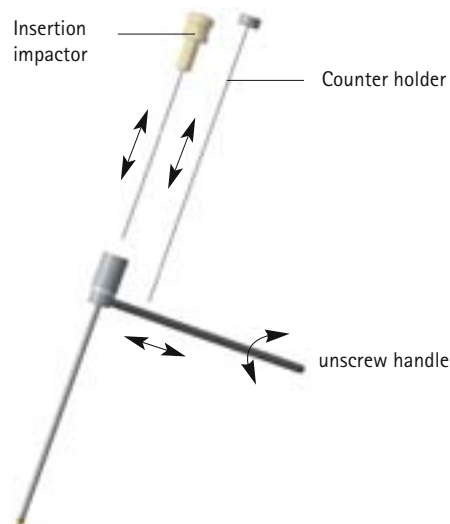

**MACS II Torque Wrench for Fixation Nut**  
FW416R

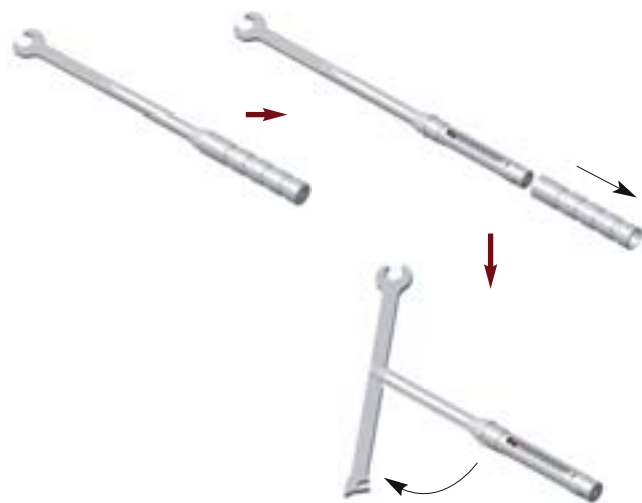

**MACS TL Screwdriver for Stabilisation**  
Screw violet  
(also see TA011177)  
FW342R



# G | Set Overview

## Implants

Qty

**NOTE:**

The implant tray can be equipped according to your needs. We only indicate recommended quantities.

- **MACS II Implant Tray 1**  
(without implants)  
SX848R
- **Tray Lid**  
JH217R
- **MACS II Packing Template Implants**  
TF010

1

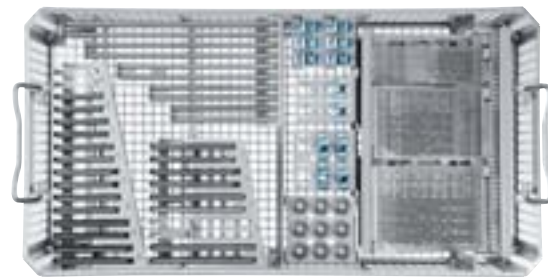

1

1





Screw tray to SX848R



**NOTE:**

For cleaning and storage the screw tray is positioned up-side down into the implant tray.

## Implants

	Qty	
<b>Polyaxial Screw</b> Ø 7.0 mm <ul style="list-style-type: none"> <li>■ SX790T 15 mm</li> <li>■ SX791T 20 mm</li> <li>■ SX792T 25 mm</li> <li>■ SX793T 30 mm</li> <li>■ SX794T 35 mm</li> <li>■ SX795T 40 mm</li> <li>■ SX796T 45 mm</li> <li>■ SX797T 50 mm</li> <li>■ SX798T 55 mm</li> </ul>	4 4 4 4 4 4 4 4 4	<i>max. 6 pcs each</i>  
<b>Stabilisation Screw Lumbar</b> Ø 6.5 mm <ul style="list-style-type: none"> <li>■ SX782T 25 mm</li> <li>■ SX783T 30 mm</li> <li>■ SX784T 35 mm</li> <li>■ SX785T 40 mm</li> <li>■ SX786T 45 mm</li> <li>■ SX787T 50 mm</li> </ul>	4 4 4 4 4 4	<i>max. 6 pcs each</i>  
<b>Stabilisation Screw Thoracic</b> Ø 4.5 mm <ul style="list-style-type: none"> <li>■ SX826T 15 mm</li> <li>■ SX827T 20 mm</li> <li>■ SX828T 25 mm</li> <li>■ SX829T 30 mm</li> </ul>	4 4 4 4	<i>max. 4 pcs each</i>  
<b>Polyaxial Screw XL</b> Ø 10 mm <ul style="list-style-type: none"> <li>■ SX821T 30 mm</li> <li>■ SX823T 40 mm</li> </ul>	2 2	<i>max. 3 pcs each</i>  
<b>Fixation Nut</b> Thread M11 <ul style="list-style-type: none"> <li>■ SX802T</li> </ul>	8	<i>max. 9 pcs</i>  





## Instruments

### MACS II Instrument Set – FW393

Qty

**NOTE:**

Only order of set number FW393 possible (instrument tray, packing template, instruments).

*Consisting:*

- |   |                            |
|---|----------------------------|
| <ul style="list-style-type: none"> <li>■ <b>MACS II Instrument Tray 1</b><br/>FW391R</li> <li>■ <b>MACS II Instrument Tray 2 Bottom / Top</b><br/>FW392R</li> <li>■ <b>Tray Lid</b><br/>JH217R</li> </ul>                               | <p>1</p> <p>1</p> <p>2</p> |
| <ul style="list-style-type: none"> <li>■ <b>MACS II Packing Template FW391R</b><br/>TF030</li> <li>■ <b>MACS II Packing Template FW392R Bottom</b><br/>TF031</li> <li>■ <b>MACS II Packing Template FW392R Top</b><br/>TF032</li> </ul> | <p>1</p> <p>1</p> <p>1</p> |



FW391R

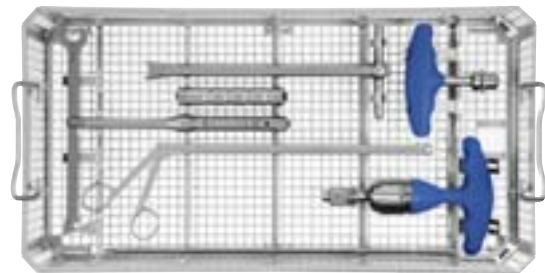



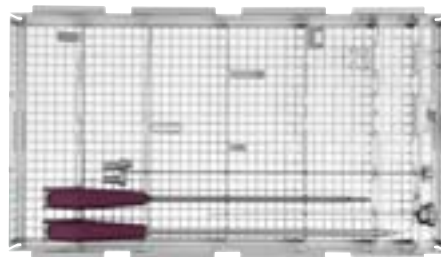







FW392R Bottom



FW392R Top (without optional instruments)

# G | Set Overview

## Instruments

Instrument Tray 1 – FW391R		Qty	
MACS TL Screw Revision Instrument FW336R	1		
MACS II K-Wire Protection Sleeve FW394R	2		Length: 68 mm
MACS II Ball Screwdriver FW396R	1		
MACS II Insertion Tube FW397R	2		
MACS II Cannulated Screwdriver FW398R	1		
MACS II Counter Torque Handle FW399R	1		
MACS II Punch Lumbar FW407R	1		
MACS II K-Wire Insertion Instrument FW408R	1		
MACS II Target Sleeve for Anterior Stabilisation Screw FW409R	1		L-shaped handle Length : 317 mm
MACS II Torque Wrench for Mounting of Pre-Assembled Set Screw 1.8 Nm FW419R	1		
MACS II Mounting Block for Pre- Assembled Set Screw SX804T FW429	1		

## Instruments



Instrument Tray 2 – FW392R Bottom		Qty	
MACS TL Plate / Rod-Holding Forceps FW326R	1		
MACS II T-Handle 1/4" Coupling FW395R	1		
MACS II Screwdriver for Set Screw FW411R	1		
MACS II Torque Wrench for Set Screw 10 Nm FW412R	1		
MACS II Torque Wrench for Fixation Nut 15 Nm FW416R	1		
MACS II Nut Driver for Fixation Nut, Size 16 FW417R	1		
Instrument Tray 2 – FW392R Top		Qty	
MACS TL Screwdriver for Stabilisation Screw Thoracic (Violet) FW342R	1		
MACS TL Punch for Stabilisation Screw Thoracic (Violet) FW405R	1		
MACS II Target Sleeve for Thoracic Stabilisation Screw FW413R	1		

Length: 317 mm

# G | Set Overview

## Instruments

Not included in set number:

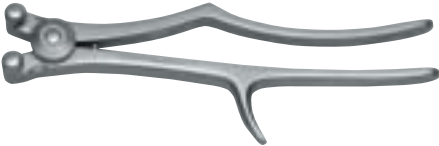
Optional Instruments	Qty	
<b>MIASPAS TL Measuring Instrument <sup>1</sup></b> FG045R	1	
<b>Slotted Hammer <sup>2</sup></b> FW243R	1	
<b>SSE Rod Bending Forceps <sup>2</sup></b> FW013R  <sup>1</sup> As soon as new version available, storage in instrument tray FW392 top possible <sup>2</sup> Storage in instrument tray FW392 top possible	1	

## Packing Templates

<b>MACS II Grafic Packing Template</b> FW391R TF001	1	
<b>MACS II Grafic Packing Template</b> FW392R (double labeled) TF002	1	

## Containers

Recommended Containers	Qty	
<b>Container Body 592 x 274 x 120 mm (without perforation)</b> JK441	1	
<b>Container Body 592 x 274 x 135 mm (without perforation)</b> JK442	2	
<b>Container Lid Silver</b> JK489	3	





